

KaWe EUROLIGHT®

FAMILIE | PRODUCT LINE

KaWe EUROLIGHT® Ophthalmoskope | ophthalmoscopes

2,5 V
1 Blende | 1 aperture

1	E10	VL	
2	E30	VL	

2,5 V
5 Blenden | 5 apertures

3	E15	VL	
---	-----	----	---

2,5 V
6 Blenden | 6 apertures

4	E36 (EU)	XH	
5	E36 (US)	XH	

3,5 V
6 Blenden | 6 apertures

6	E36 (EU)	XH	 
7	E36 (EU)	XH	

Funktion und Design in ihrer besten Form.

KaWe EUROLIGHT® sind hochwertige Ophthalmoskope, wahlweise mit 1,5 oder 6 Blenden. Die ausgereifte Linsen-Optik im Inneren des Ophthalmoskop-Kopfes ermöglicht eine schattenlose und optimale Abbildungsqualität. Die Xenon/Halogen-/Vakuum-Lampe gewährleistet eine authentische Farbwiedergabe.

Function and design at their best.

The KaWe EUROLIGHT® is a high-quality ophthalmoscope available with 1, 5 or 6 apertures. The technically mature lens optics inside of the ophthalmoscope head enable an optimal image quality with no shading. The xenon/halogen-vacuum lamp ensures authentic colour reproduction.

KaWe EUROLIGHT® E30

- Clic-Verschluss
- Vakuum-Lampe
- Metall-Batterie-/Ladegriff C
- Rheostat dimmbar
- mit Korrektionslinsenrad stufenweise von +20 bis –20 Dioptrien
- in Reißverschluss tasche
- Batterien: 2x Baby 1,5 V (Typ C) 
- 1 Blende
- Gute und gleichmäßige Ausleuchtung!
- Sehr großes Untersuchungsfeld des Augenhintergrundes.

- click-on connection
- vacuum bulb
- metal battery/charging handle C
- dimmable rheostat
- with lens correction dial incremental steps from +/- 20 dioptries
- in bag with zipper
- batteries: 2 C batteries, 1.5V 
- 1 aperture
- Good and uniform illumination!
- Very large examination field of the fundus of the eye.



1 Blende
1 aperture



2 E30 | 2,5 V | VL  REF 01.21300.001 (27030)

Leuchtmittel | Illuminant REF 12.75112.003 (28944)

KaWe EUROLIGHT® E15

- Schraubverschluss
- Vakuum-Lampe
- Metall-Batterie-/Ladegriff C
- Rheostat dimmbar
- mit Korrektionslinsenrad stufenweise von +20 bis –20 Dioptrien
- in Reißverschluss tasche
- Batterien: 2x Baby 1,5 V (Typ C) 
- 5 Blenden
- Gute und gleichmäßige Ausleuchtung!
- Sehr großes Untersuchungsfeld des Augenhintergrundes.

- connection with fastening screw
- vacuum bulb
- metal battery/charging handle C
- dimmable rheostat
- with lens correction dial incremental steps from +20 to –20 dioptries
- in bag with zipper
- batteries: 2 C batteries, 1.5V
- 5 apertures
- Good and uniform illumination!
- Very large examination field of the fundus of the eye.



5 Blenden
5 apertures



3 E15 | 2,5 V | VL  REF 01.21155.001

Leuchtmittel | Illuminant REF 12.75113.003 (28947)

KaWe EUROLIGHT® E10

- Schraubverschluss
- Vakuum-Lampe
- Metall-Batterie-/Ladegriff C
- Rheostat dimmbar
- mit Korrektionslinsenrad stufenweise von +20 bis –20 Dioptrien
- in Reißverschluss tasche
- Batterien: 2x Baby 1,5 V (Typ C) 
- 1 Blende
- Gute und gleichmäßige Ausleuchtung!
- Sehr großes Untersuchungsfeld des Augenhintergrundes.

- connection with fastening screw
- vacuum bulb
- metal battery/charging handle C
- dimmable rheostat
- with lens correction dial incremental steps from +20 to –20 dioptries
- in bag with zipper
- batteries: 2 C batteries, 1.5V 
- 1 aperture
- Good and uniform illumination!
- Very large examination field of the fundus of the eye.

1 E10 | 2,5 V | VL  REF 01.21100.001 (27000)

Leuchtmittel | illuminant REF 12.75114.003



1 Blende
1 aperture



 aufladbar in Ladestation KaWe MedCharge® 4000 in Verbindung mit Ladebatterie / rechargeable in KaWe MedCharge® 4000 charging station with rechargeable battery

 Batterien sind nicht im Lieferumfang enthalten! / Batteries are not included!

 Ladebatterie im Lieferumfang enthalten! / rechargeable battery is included

VL Vakuum-Lampe / vacuum bulb



KaWe EUROLIGHT® E36

- Clic-Verschluss
 - 2,5 V Xenon/Halogen-Lampe
 - Metall-Batterie-/Ladegriff C
 - Rheostat dimmbar
 - mit Korrektionslinsenrad stufenweise von +20 bis -20 Dioptrien
 - in Reißverschlussstasche
 - Batterien: 2x Baby 1,5 V (Typ C) 
- 6 Blenden, hervorragende und gleichmäßige Ausleuchtung! Sehr großes Untersuchungsfeld des Augenhintergrundes.

- click-on connection
- 2.5 V xenon/halogen bulb
- metal battery/charging handle C
- dimmable rheostat
- with lens correction dial incremental steps from +/- 20 dioptries
- in bag with zipper
- batteries: 2 C batteries, 1.5 V

6 apertures, good and uniform illumination! Very large examination field of the fundus of the eye.



4	E36	2,5 V	XH		EU	REF 01.21361.001 (27070)
5	E36	2,5 V	XH		US	REF 01.21366.001 (27080)
Leuchtmittel Illuminant			REF 12.75132.003 (28946)			

KaWe EUROLIGHT®

FAMILIE | PRODUCT LINE

KaWe EUROLIGHT® E36

Merkmale:

- direkte Ophthalmoskopie
- mit sechs Blenden für vielseitige ophthalmologische Untersuchungen
- Blendenrad mit 18 Korrektionslinsen von +20 bis -20 Dioptrien
- asphärische Präzisionsoptik
- robust

Features:

- direct ophthalmoscopy
- with six apertures for all types of ophthalmoscopic examinations
- aperture selection dial with 18 correction lenses from +20 to -20 dioptries
- aspherical precision optics
- robust

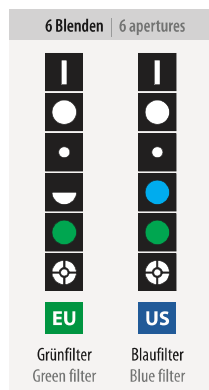

33

3,5V

KaWe EUROLIGHT® E36 3,5 V

- Clic-Verschluss
 - leistungsstarke **3,5 V** Xenon/Halogen-Lampe
 - Metall-Ladegriff C
 - Rheostat dimmbar
 - mit Korrektionslinsenrad stufenweise von +20 bis -20 Dioptrien
 - inkl. Li-Ion Ladebatterie **3,5 V** nur in Verbindung mit Ladestation KaWe MedCharge® 4000 verwendbar (▶208)
 - in Reißverschlussstasche
- 6 Blenden, hervorragende und gleichmäßige Ausleuchtung! Sehr großes Untersuchungsfeld des Augenhintergrundes.

- click-on connection
 - high-capacity **3.5 V** xenon/halogen bulb
 - metal charging handle C
 - dimmable rheostat
 - with lens correction wheel incremental steps from +/- 20 dioptries
 - incl. **3.5 V** li-ion rechargeable battery (only to be used with KaWe MedCharge® 4000 charging station (▶208))
 - in bag with zipper
- 6 apertures, good and uniform illumination! Very large examination field of the fundus of the eye.



6	E36	3,5 V	XH		EU	REF 01.25361.101
Leuchtmittel Illuminant			REF 12.75232.003 (28923)			

3,5V

NEU NEW

KaWe EUROLIGHT® E36 3,5 V

- Clic-Verschluss
 - **aufladbar in Steckdose** (EU 240 V)
 - leistungsstarke **3,5 V** Xenon/Halogen-Lampe
 - Metall-Ladegriff C
 - Rheostat dimmbar
 - inkl. NiMH Ladebatterie **3,5 V**
 - in Reißverschlussstasche
- 6 Blenden, hervorragende und gleichmäßige Ausleuchtung! Sehr großes Untersuchungsfeld des Augenhintergrundes.

- click-on connection
 - **rechargeable in electric outlet** (EU 240 V)
 - high-power **3.5 V** xenon/halogen bulb
 - metal charging handle C
 - dimmable rheostat
 - includes rechargeable battery **3.5 V**
 - in bag with zipper
- 6 diaphragms, good and uniform illumination! Very large examination field of the fundus of the eye.



7	E36	3,5 V	XH		EU	REF 01.25361.811
Leuchtmittel Illuminant			REF 12.75232.003 (28923)			

 **aufladbar in Ladestation KaWe MedCharge® 4000 in Verbindung mit Ladebatterie / rechargeable in KaWe MedCharge® 4000 charging station with rechargeable battery**
 **Batterien sind nicht im Lieferumfang enthalten! / Batteries are not included!**
 **Ladebatterie im Lieferumfang enthalten! / rechargeable battery is included**

XH Xenon/Halogen-Lampe / xenon/halogen bulb

KaWe PICCOLIGHT®

FAMILIE | PRODUCT LINE

KaWe PICCOLIGHT® Ophthalmoskope | ophthalmoscopes

2,5 V
1 Blende | 1 aperture

1	E50	VL, night
	E50	VL, sky
	E50	VL, stone

2,5 V
5 Blenden | 5 apertures

2	E55	VL, night
	E55	VL, sky
	E55	VL, stone

2,5 V
6 Blenden | 6 apertures

3	E56 (EU)	XH, night
	E56 (EU)	XH, sky
	E56 (EU)	XH, stone

2,5 V
6 Blenden | 6 apertures

4	E56 (US)	XH, night
	E56 (US)	XH, sky
	E56 (US)	XH, stone

night. sky. stone. Ein neues Blickfeld

Das Ophthalmoskop für die Manteltasche. Klein, leicht und dennoch exakt – das ist das PICCOLIGHT® von KaWe. Durch eine leistungsstarke Xenon/Halogen-/Vakuum-Lampe wird eine hervorragende Ausleuchtung des Augenhintergrundes garantiert. Das elegante Design und die stilvollen Farben machen unser KaWe PICCOLIGHT® zu einem medizinischen Instrument, das dem Anwender im täglichen Praxisalltag Freude bereiten wird.

night. sky. stone. A new focus

The coat pocket ophthalmoscope. Small, easy and yet exact – this is the KaWe PICCOLIGHT®. A high-capacity xenon/halogen/vacuum lamp ensures the excellent illumination of the eye fundus. Its elegant design and the classy colours make the KaWe PICCOLIGHT® a medical instrument that is a pleasure to use day in and day out.

KaWe PICCOLIGHT® E50

- Batteriegriff (AA)
- 2,5 V Vakuum-Lampe
- mit Korrektionslinsenrad
stufenweise von +20 bis –20 Dioptrien
- asphärische Präzisionsoptik
- in Stofftasche
- Batterien: 2 Mignon 1,5 V (Typ AA)

1 Blende

Gute und gleichmäßige Ausleuchtung!
Sehr großes Untersuchungsfeld
des Augenhintergrundes.

- battery handle (AA)
- 2.5 V vacuum bulb
- with lens correction dial
incremental steps from +20 to -20 dioptres
- aspherical precision optics
- in cloth bag
- batteries: 2 Mignon 1.5 V (type AA)

1 aperture

Excellent, uniform illumination!
Very large examination field
of the fundus of the eye.



1 Blende
1 aperture



1	E50	2,5 V	VL	night	REF 01.23500.021
	E50	2,5 V	VL	sky	REF 01.23500.231
	E50	2,5 V	VL	stone	REF 01.23500.261
	Leuchtmittel illuminant				REF 12.75112.003 (28944)

KaWe PICCOLIGHT® E55

- Batteriegriff (AA)
- 2,5 V Vakuum-Lampe
- mit Korrektionslinsenrad
stufenweise von +20 bis –20 Dioptrien
- asphärische Präzisionsoptik
- in Stofftasche
- Batterien: 2 Mignon 1,5 V (Typ AA)

5 Blenden

Gute und gleichmäßige Ausleuchtung!
Sehr großes Untersuchungsfeld
des Augenhintergrundes.

- battery handle (AA)
- 2.5 V vacuum bulb
- with lens correction dial
incremental steps from +20 to -20 dioptres
- aspherical precision optics
- in cloth bag
- batteries: 2 Mignon 1.5 V (type AA)

5 apertures

Excellent, uniform illumination!
Very large examination field
of the fundus of the eye.



5 Blenden
5 apertures



2	E55	2,5 V	VL	night	REF 01.23555.021
	E55	2,5 V	VL	sky	REF 01.23555.231
	E55	2,5 V	VL	stone	REF 01.23555.261
	Leuchtmittel illuminant				REF 12.75112.003 (28944)

Batterien sind nicht im Lieferumfang enthalten! / Batteries are not included!

VL Vakuum-Lampe / vacuum bulb



KaWe PICCOLIGHT® E56
Merkmale:

- direkte Ophthalmoskopie
- mit sechs Blenden für vielseitige ophthalmologische Untersuchungen
- Blendenrad mit 18 Korrektionslinsen von +20 bis -20 Dioptrien
- asphärische Präzisionsoptik
- Taschenformat, leicht, handlich, modernes Design

Features:

- direct ophthalmoscopy
- with six apertures for all types of ophthalmoscopic examinations
- aperture selection dial with 18 correction lenses from +20 to -20 dioptres
- aspherical precision optics
- pocket-size, light-weight, handy, modern design

*Abstand Luxmeter – Lichtaustritt: 30 mm
*Distance of luxmeter from light source: 30 mm

Beleuchtungsstärke KaWe Ophthalmoskope **2,5 V**
Illuminance of KaWe ophthalmoscopes **3,5 V**

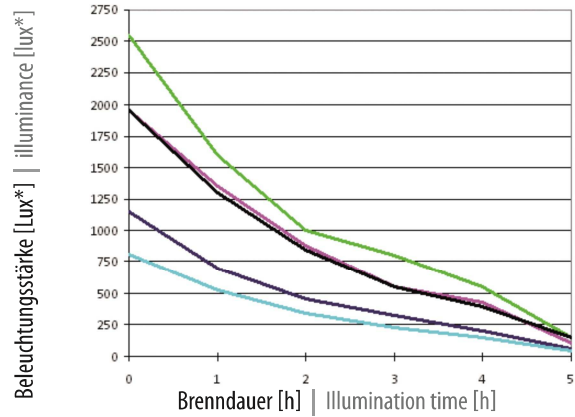

— KaWe EUROLIGHT® E10+E15+E30 Vakuu-Lampe bulb	2,5 V	2,5 V
— KaWe EUROLIGHT® E36 Xenon/Halogen-Lampe bulb	2,5 V	2,5 V
— KaWe EUROLIGHT® E36 Xenon/Halogen-Lampe bulb	3,5 V	3,5 V
— KaWe PICCOLIGHT® E50+E55 Vakuu-Lampe bulb	2,5 V	2,5 V
— KaWe PICCOLIGHT® E56 Xenon/Halogen-Lampe bulb	2,5 V	2,5 V

KaWe PICCOLIGHT® E56 / EU

- Batteriegriff (AA)
- 2,5 V Xenon/Halogen-Lampe
- mit Korrektionslinsenrad stufenweise von +20 bis -20 Dioptrien
- asphärische Präzisionsoptik
- in Stofftasche
- Batterien: 2 Mignon 1,5 V (Typ AA)

6 Blenden
Hervorragende und gleichmäßige Ausleuchtung!
Sehr großes Untersuchungsfeld des Augenhintergrundes.

- battery handle (AA)
- 2.5 V xenon/halogen bulb
- with lens correction dial incremental steps from +/- 20 dioptres
- aspherical precision optics
- in cloth bag
- batteries: 2 Mignon, 1.5V (type AA)

6 apertures
Excellent, uniform illumination!
Very large examination field of the fundus of the eye.



6 Blenden
6 apertures



EU
Grünfilter
Green filter

3	E56	EU	2,5 V XH	night	REF 01.23561.021
	E56	EU	2,5 V XH	sky	REF 01.23561.231
	E56	EU	2,5 V XH	stone	REF 01.23561.261

Leuchtmittel | illuminant REF 12.75132.003 (28946)

KaWe PICCOLIGHT® E56 / US

- Batteriegriff (AA)
- 2,5 V Xenon/Halogen-Lampe
- mit Korrektionslinsenrad stufenweise von +20 bis -20 Dioptrien
- asphärische Präzisionsoptik
- in Stofftasche
- Batterien: 2 Mignon 1,5 V (Typ AA)

6 Blenden
Hervorragende und gleichmäßige Ausleuchtung!
Sehr großes Untersuchungsfeld des Augenhintergrundes.

- battery handle (AA)
- 2.5 V xenon/halogen bulb
- with lens correction dial incremental steps from +/- 20 dioptres
- aspherical precision optics
- in cloth bag
- batteries: 2 Mignon, 1.5V (type AA)

6 apertures
Excellent, uniform illumination!
Very large examination field of the fundus of the eye.



6 Blenden
6 apertures



US
Blaufilter
Blue filter

4	E56	US	2,5 V XH	night	REF 01.23566.021
	E56	US	2,5 V XH	sky	REF 01.23566.231
	E56	US	2,5 V XH	stone	REF 01.23566.261

Leuchtmittel | illuminant REF 12.75132.003 (28946)

Batterien sind nicht im Lieferumfang enthalten! / Batteries are not included!

XH Xenon/Halogen-Lampe / xenon/halogen bulb

KaWe EUROLIGHT®

OPHTHALMOSKOP-KÖPFE | OPHTHALMOSCOPE HEADS

36

E10

KaWe EUROLIGHT®



2,5 V | VL
1 Blende | 1 aperture

REF 01.81100.001 (27001)

E15

KaWe EUROLIGHT®



2,5 V | VL
5 Blenden | 5 apertures

REF 01.81155.001

E16

KaWe EUROLIGHT®



2,5 V | VL
6 Blenden | 6 apertures

REF 01.81161.001

E30

KaWe EUROLIGHT®



2,5 V | VL
1 Blende | 1 aperture

REF 01.81300.001 (27031)

**NEU
NEW**

E36

KaWe EUROLIGHT®



EU

2,5 V | XH
6 Blenden | 6 apertures

REF 01.81361.001 (27071)



US

2,5 V | XH
6 Blenden | 6 apertures

REF 01.81366.001 (27081)

E36

KaWe EUROLIGHT®

3,5 V



EU

3,5 V | XH
6 Blenden | 6 apertures

REF 01.85361.001



US

3,5 V | XH
6 Blenden | 6 apertures

REF 01.85366.001

KaWe EUROLIGHT®

GRIFFE | HANDLES

KaWe EUROLIGHT®

Batterie-/Ladegriff C | Battery/charging handle C

für | for
KaWe EUROLIGHT® C, E

für | for REF
01.11110.001 (24810),
01.12110.001 (26480),
01.21100.001 (27000),
01.21155.001,

02.01008.002,
02.01104.002,
02.11001.002 (27105),
02.11002.001 (27100)



C10 | 2,5 V | Ø 28 mm

REF **01.74110.002** (24815)

C10 | 2,5 V | Ø 28 mm
inkl. | includes NiMH

REF **01.74110.052**

KaWe EUROLIGHT®

Batterie-/Ladegriff C | Battery/charging handle C

für | for
KaWe EUROLIGHT® C30, F.O., VET, E, D,
KaWe COMBILIGHT® F.O.

für | for REF
01.11130.001 (24830),
01.11135.001 (24855),
01.11136.001,
01.11330.001 (24750),
01.11530.002,
01.11534.001,
01.12330.001 (26500),
01.12530.002,
01.21300.001 (27030),
01.21361.001 (27070),
01.21366.001 (27080),
01.31130.001 (26790),

02.13004.001,
02.15004.002,
02.23001.001 (27130),
02.23004.001,
02.25004.002



C30 | 2,5 V | Ø 28 mm

REF **01.74130.002** (24835)

C30 | 2,5 V | Ø 28 mm
inkl. | includes NiMH

REF **01.74130.052**

KaWe EUROLIGHT®

3,5 V

Ladegriff C30
Charging handle C30

für | for
KaWe EUROLIGHT® F.O., E,
KaWe COMBILIGHT® F.O.

für | for REF
01.11430.101,
01.11830.101,
01.12430.101,
01.12830.101,
01.25361.101,

02.18004.002,
02.24004.102,
02.24005.102,
02.28004.002



C30 | **3,5 V** | Ø 28 mm
inkl. | includes Li-Ion

REF **01.74131.062**

KaWe EUROLIGHT®

3,5 V

Ladegriff für Steckdose
Charging handle for electric outlet

für | for
KaWe EUROLIGHT® F.O.30, E36, D30 LED
KaWe COMBILIGHT® F.O.30

für | for REF
01.11430.811 (26520),
01.12430.811 (26550),
01.25361.811,
01.31630.811

aufklarbar in der Steckdose
(ohne Ladebatterie!)
rechargeable in electric outlet
(without rechargeable battery!)



EU
C | **3,5 V** | 240 V (EU)
Ø 28 mm

REF **01.74180.812** (26560)

Ladebatterie **3,5 V** Rechargeable battery

aufklarbar in Steckdose
rechargeable in electric outlet

für Metall-Ladegriff C
for metal charging handle C



3,5 V | NiMH
kurz | short

REF **12.80120.742** (28970)

aufklarbar in Ladestation KaWe MedCharge® 4000 in Verbindung mit Ladebatterie / rechargeable in KaWe MedCharge® 4000 charging station with rechargeable battery
 Ladebatterie im Lieferumfang enthalten / rechargeable battery is included

KaWe PICCOLIGHT®

OPHTHALMOSKOP-KÖPFE | OPHTHALMOSCOPE HEADS

38

KaWe PICCOLIGHT® E50

2,5 V | VL



night	01.83500.021
sky	01.83500.231
stone	01.83500.261

KaWe PICCOLIGHT® E55

2,5 V | VL



night	01.83555.021
sky	01.83555.231
stone	01.83555.261

KaWe PICCOLIGHT® E56

2,5 V | XH



EU

night	01.83561.021
sky	01.83561.231
stone	01.83561.261



US

night	01.83566.021
sky	01.83566.231
stone	01.83566.261

GRIFFE | HANDLES

KaWe PICCOLIGHT® Griffe | Handles

Batterie-Griff AA 2,5 V
Battery handle AA 2.5 V

für folgende KaWe PICCOLIGHT®
Otoskope, Ophthalmoskope und
Dermatoskop

for the following KaWe PICCOLIGHT®
otoscopes, ophthalmoscopes and
dermatoscope

REF

night	sky	stone
01.13100.021, 01.13100.232, 01.13100.262, 01.13300.021, 01.13300.232, 01.13300.262, 01.13500.021, 01.13500.232, 01.13500.262, 01.13600.021, 01.13600.232, 01.13600.262, 01.23500.021, 01.23500.231, 01.23500.261, 01.23555.021, 01.23555.231, 01.23555.261, 01.23561.021, 01.23561.231, 01.23561.261, 01.23566.021, 01.23566.231, 01.23566.261 01.33100.021 (26810)		

night	REF 01.74200.021
sky	REF 01.74200.231
stone	REF 01.74200.261



TASCHEN | BAGS

KaWe PICCOLIGHT® Stofftasche | Cloth bag



schwarz | black REF 01.78401.021 (24943)

Reißverschlusstasche Bag with zipper



für | for
KaWe EUROLIGHT® / KaWe COMBILIGHT®

schwarz | black REF 01.78301.001 (24838)







VL Vakuum-Lampe / vacuum bulb
XH Xenon/Halogen-Lampe / xenon/halogen bulb

BLENDEN | APERTURES

Blenden

	Spaltblende	zur Unterscheidung bei Niveaudifferenzen (z.B. bei Tumoren oder Papilloedem)
	großer Kreis	für normale Fundus-Untersuchungen
	kleiner Kreis	zur Reflexreduzierung bei kleinen Pupillen
	Halbkreis	zur Reflexreduzierung bei kleinen Pupillen
	Kobaltblau – großer Kreis	Die Angiographie dient zur Untersuchung bzw. zur Verlaufskontrolle von Augenerkrankungen, wie z.B. Durchblutungsstörungen, Tumore oder Veränderungen der Aderhaut, Gefäßanomalien.
	rotfrei (grün) – großer Kreis	zur Erkennung feiner Gefäßveränderungen, filtert rote Lichtstrahlen im Beobachterfeld.
	Fixierhilfe	zur Feststellung von zentralen und exzentrischen Fixationen

Diaphragms

	Slit aperture	to differentiate level differences (e.g. in the case of tumors or papilloedema)
	Large circle	for normal fundus examinations
	Small circle	for reflex reduction when the pupils are small
	Semi-circle	for reflex reduction when the pupils are small
	Cobalt blue – large circle	angiography is used for the examination and/or follow-up of eye diseases such as circulatory disorders, tumors or changes in the choroid coat, vessel anomalies
	Red-free (green) – large circle	for the recognition of fine vessel modifications, filters red light beams within the observation field
	Fixing aid	for the determination of central and eccentric fixations

EINBLICKE | INSIGHTS

KaWe EUROLIGHT® und KaWe PICCOLIGHT® überzeugen nicht nur durch ihre kompakte und ansprechende Bauweise, sondern vor allem durch ihre ausgeklügelte und hoch entwickelte optische Technik im Innern des jeweiligen Linsenkopfes. So sorgen in allen Varianten der KaWe 6-Blenden Ophthalmoskope 18 sorgfältig aufeinander abgestimmte Linsen für eine optimale Bündelung des Lichtstrahls. Wobei der Sehwinkel der Beleuchtung +/- 7° beträgt und damit einen groß ausgeleuchteten und schattenfreien Bereich auf der Netzhaut garantiert. Ob Sie sich für ein Gerät mit einer, fünf oder mit sechs Blenden entscheiden, die langlebige Xenon/Halogen- oder Vakuum-Lampe bringt immer ein extrem helles Licht mit einer guten Farbwiedergabe.

KaWe EUROLIGHT® and KaWe PICCOLIGHT® will please you not only with their compact and appealing design, but also with their sophisticated and highly-developed optical technology inside of their respective lens heads. Thus, in all variants of the KaWe 6-aperture ophthalmoscopes, 18 accurately harmonised lenses enable optimal focussing of the light beam. Thereby, the angle of vision of the illumination is +/- 7° and thus ensuring a large illumination field and an examination area on the retina that is free of shadows. Regardless of whether you choose a unit with one or with six apertures, the long-lasting xenon/halogen or vacuum incandescent lamp will always ensure an extremely bright light with great colour reproduction.

Schematische Darstellung der direkten Ophthalmoskopie

Schematic diagram of direct ophthalmoscopy

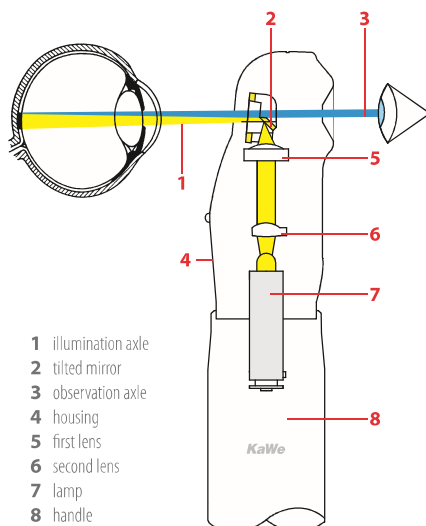

- | | |
|---------------------|---------------------|
| 1 Beleuchtungsachse | 1 illumination axle |
| 2 Umlenkspiegel | 2 tilted mirror |
| 3 Beobachterachse | 3 observation axle |
| 4 Gehäuse | 4 housing |
| 5 erste Linse | 5 first lens |
| 6 zweite Linse | 6 second lens |
| 7 Lampe | 7 lamp |
| 8 Griff | 8 handle |

